

Calcul des Angles du Triangle (A)

Calculez l'angle manquant dans chaque triangle.

1.

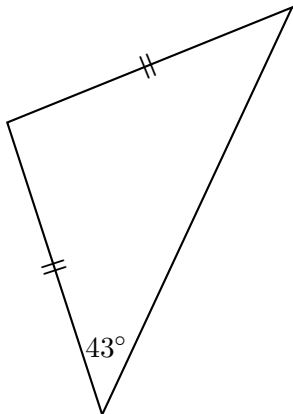

2.

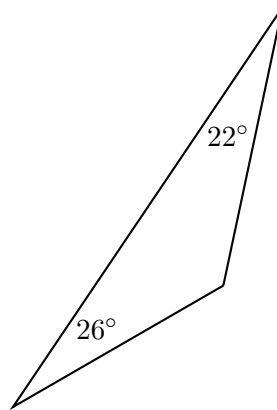

3.

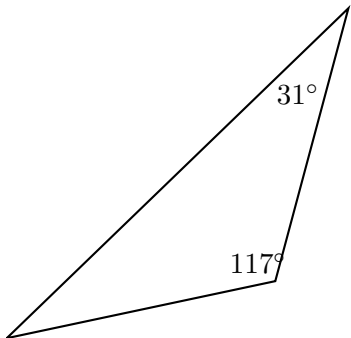

4.

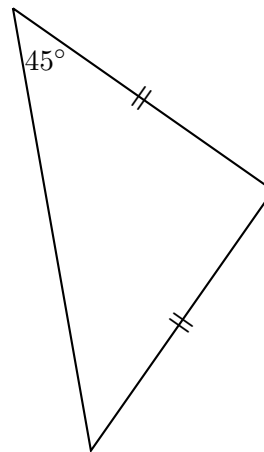

5.

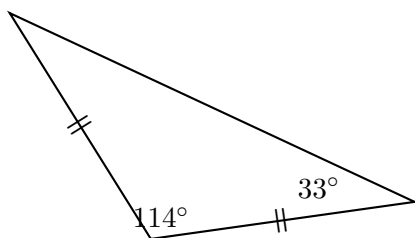

6.

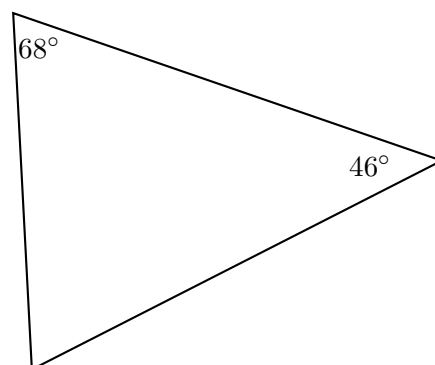

Calcul des Angles du Triangle (A) Réponses

Calculez l'angle manquant dans chaque triangle.

1.

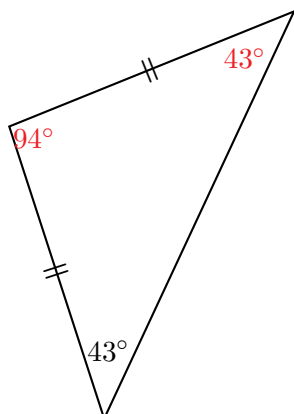

2.

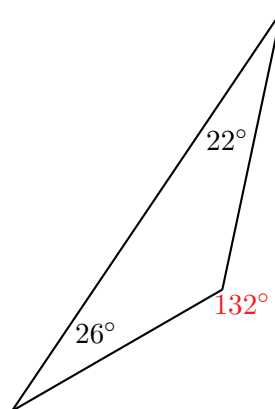

3.

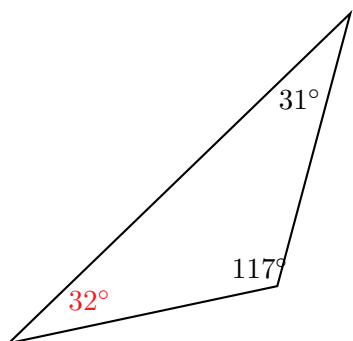

4.

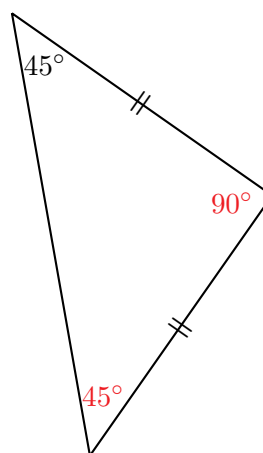

5.

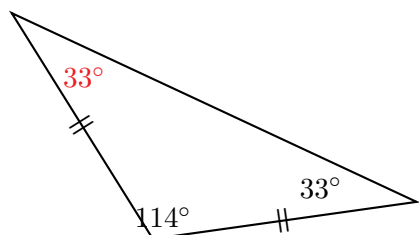

6.

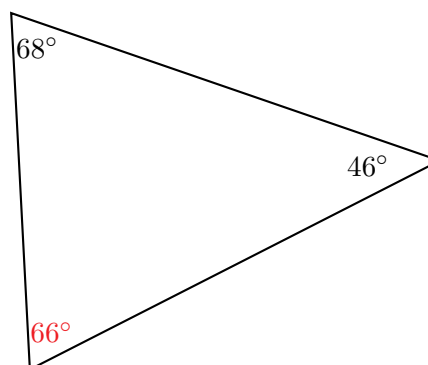

Calcul des Angles du Triangle (B)

Calculez l'angle manquant dans chaque triangle.

1.

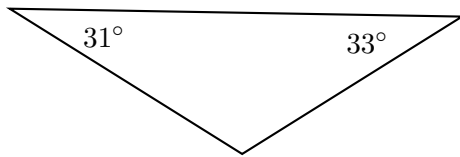

2.

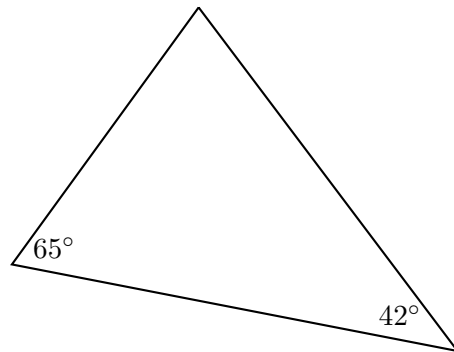

3.

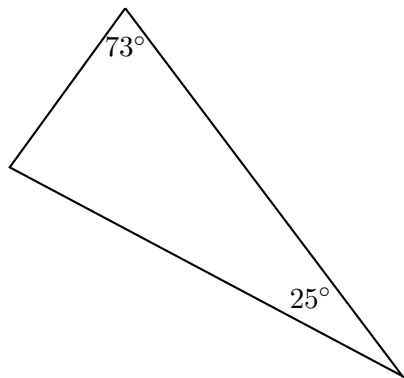

4.

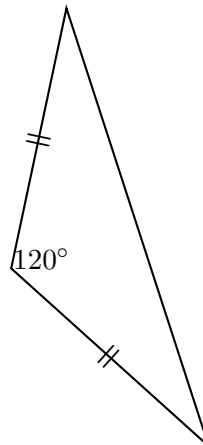

5.

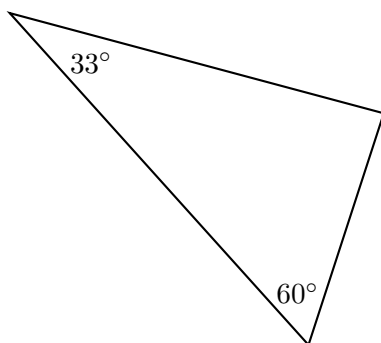

6.

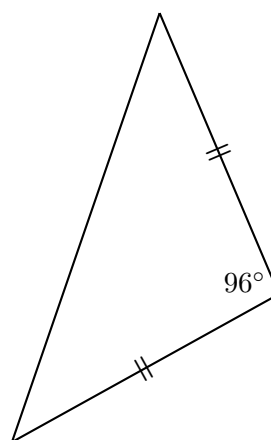

Calcul des Angles du Triangle (B) Réponses

Calculez l'angle manquant dans chaque triangle.

1.

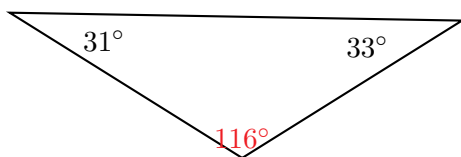

2.

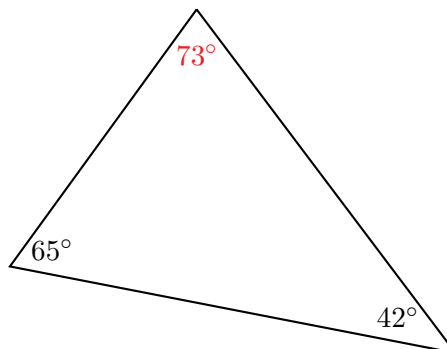

3.

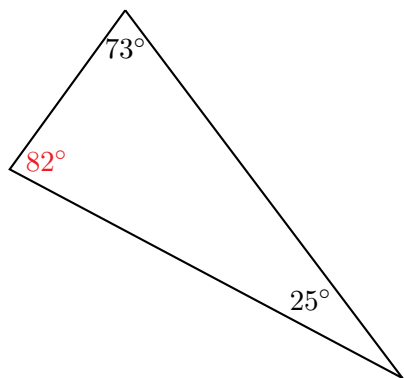

4.

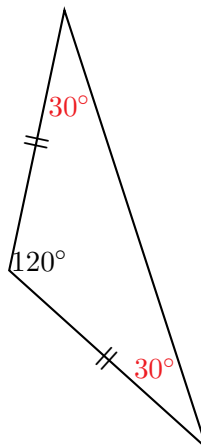

5.

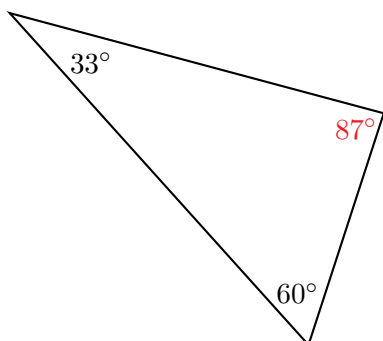

6.

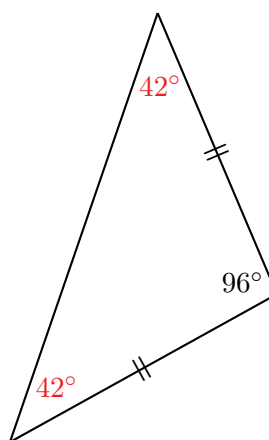

Calcul des Angles du Triangle (C)

Calculez l'angle manquant dans chaque triangle.

1.

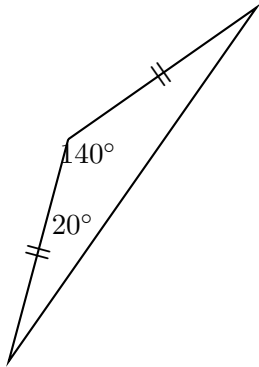

2.

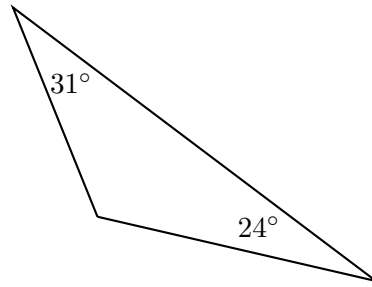

3.

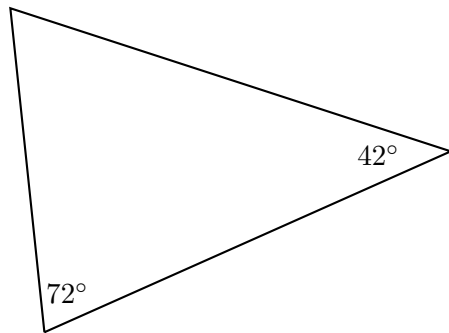

4.

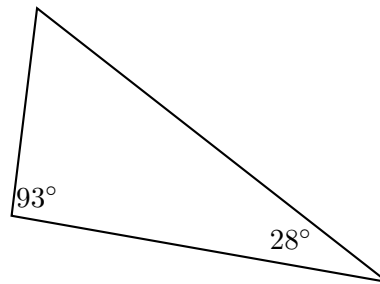

5.

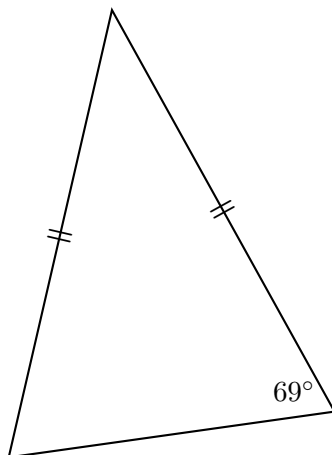

6.

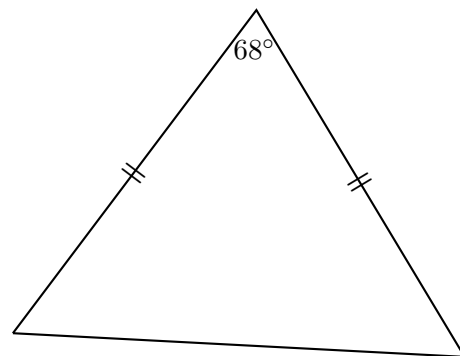

Calcul des Angles du Triangle (C) Réponses

Calculez l'angle manquant dans chaque triangle.

1.

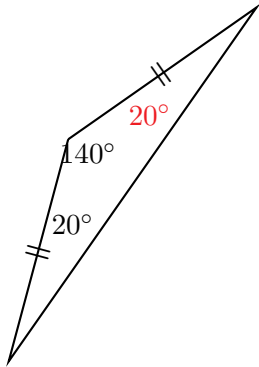

2.

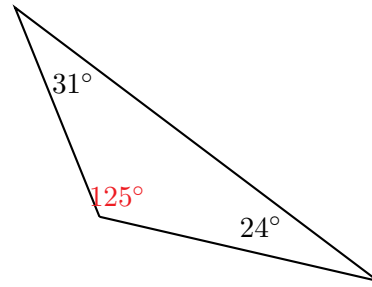

3.

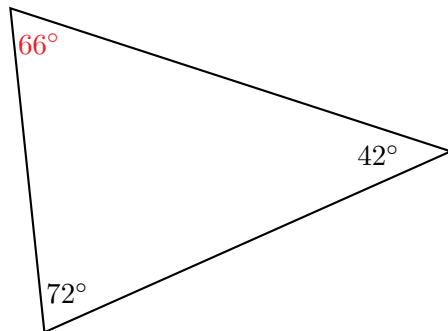

4.

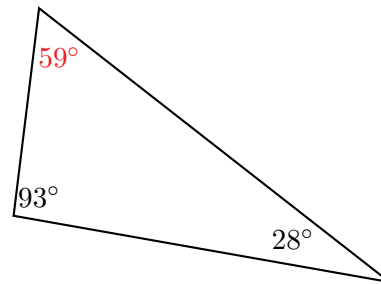

5.

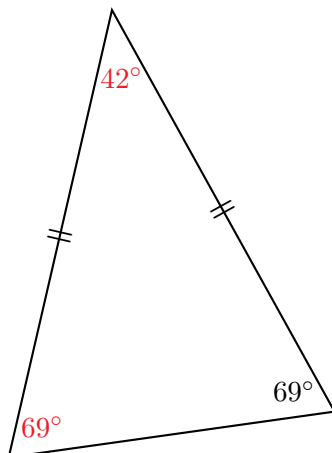

6.

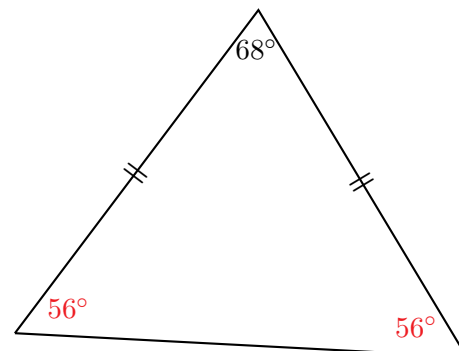

Calcul des Angles du Triangle (D)

Calculez l'angle manquant dans chaque triangle.

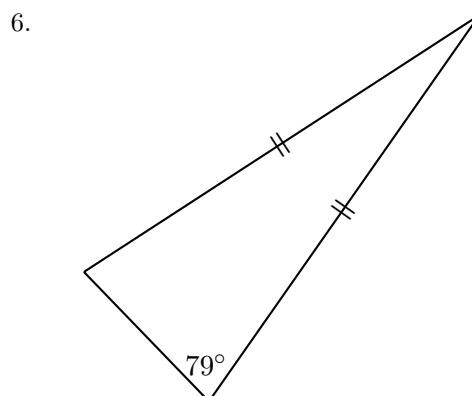
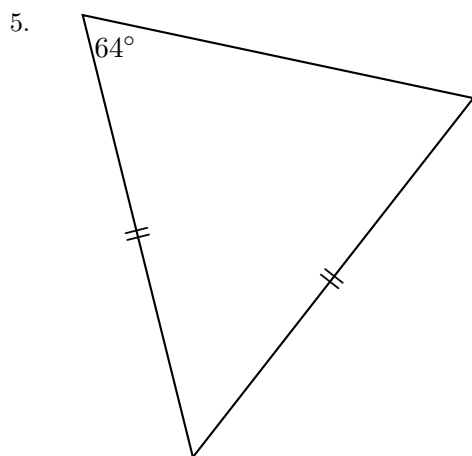
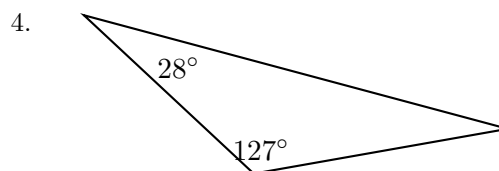
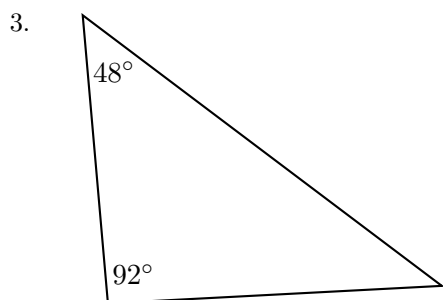
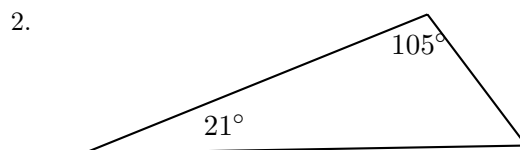
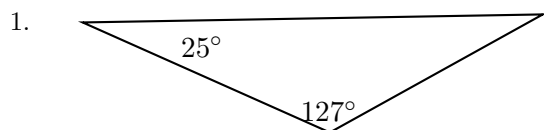

Calcul des Angles du Triangle (D) Réponses

Calculez l'angle manquant dans chaque triangle.

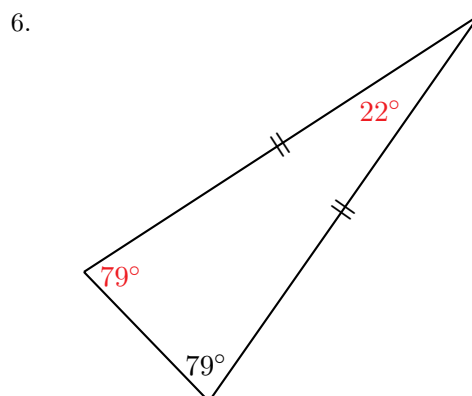
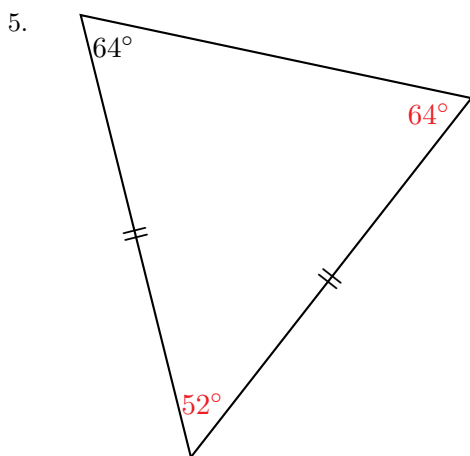
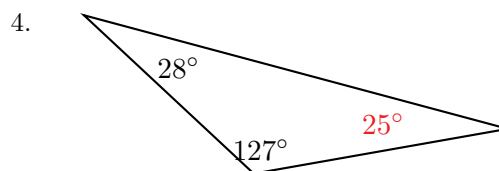
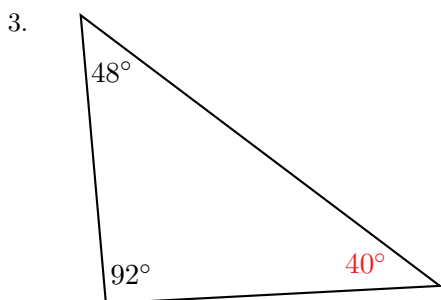
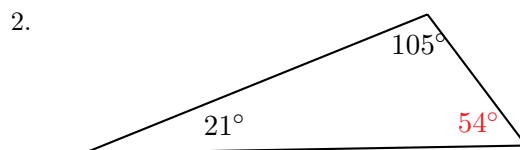
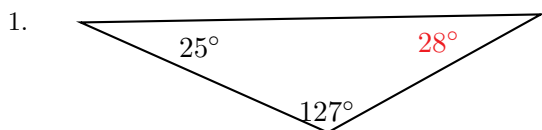

Calcul des Angles du Triangle (E)

Calculez l'angle manquant dans chaque triangle.

1.

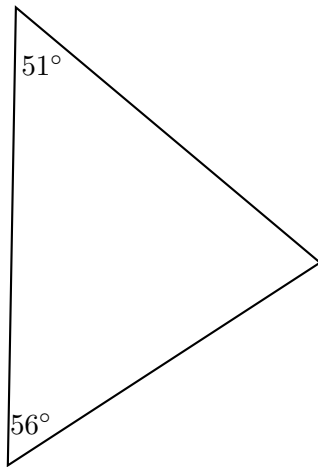

2.

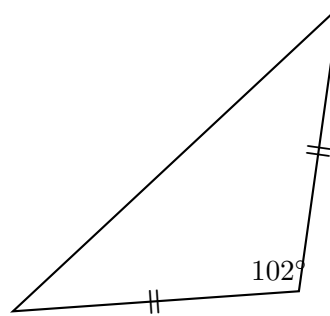

3.

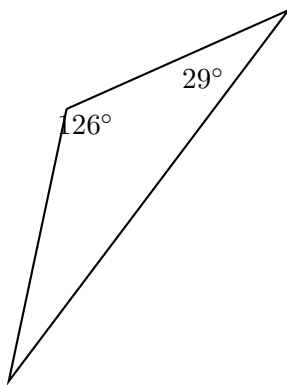

4.

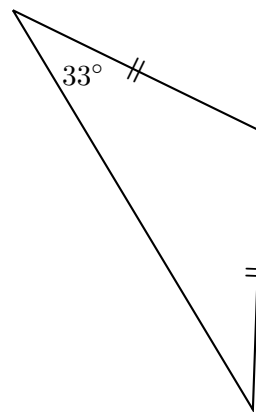

5.

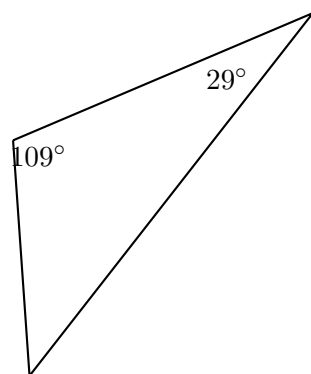

6.

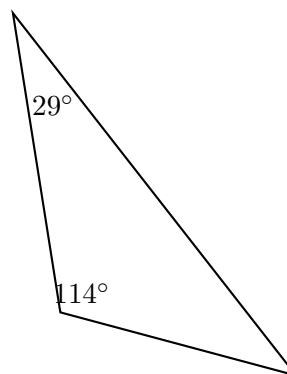

Calcul des Angles du Triangle (E) Réponses

Calculez l'angle manquant dans chaque triangle.

1.

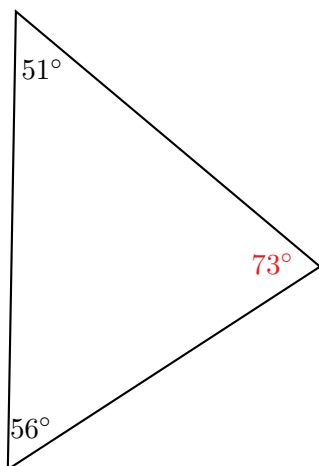

2.

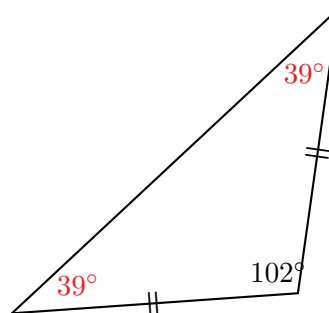

3.

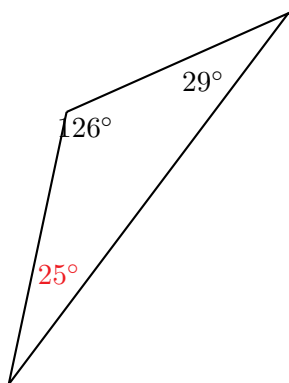

4.

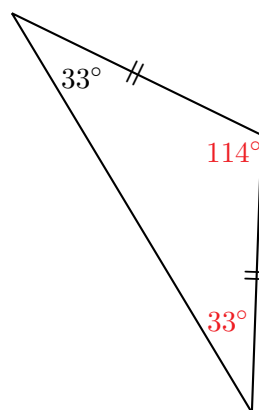

5.

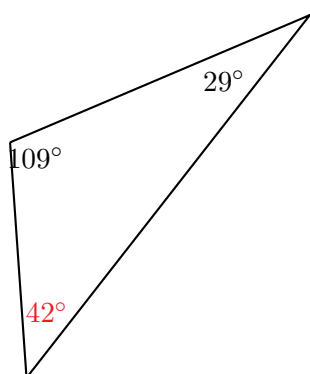

6.

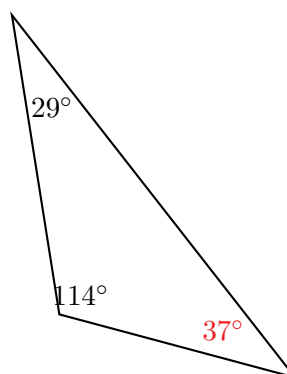

Calcul des Angles du Triangle (F)

Calculez l'angle manquant dans chaque triangle.

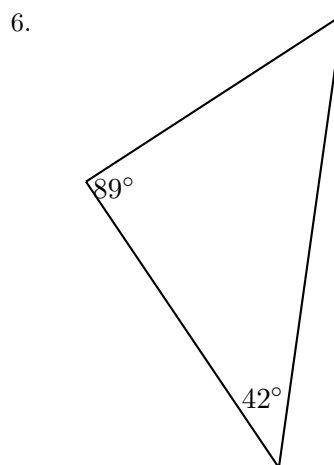
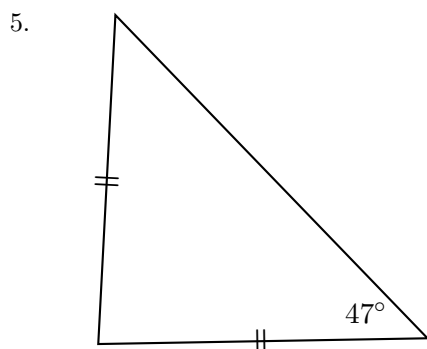
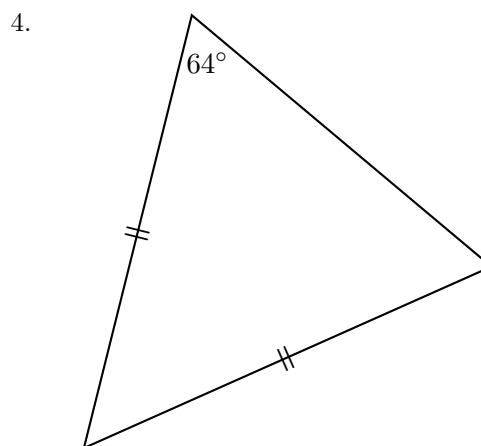
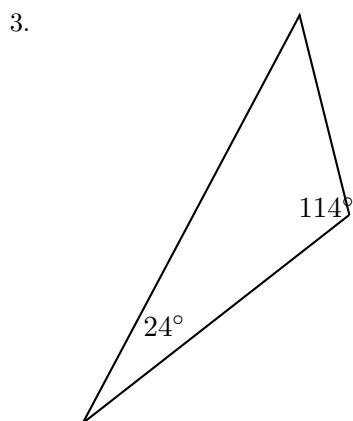
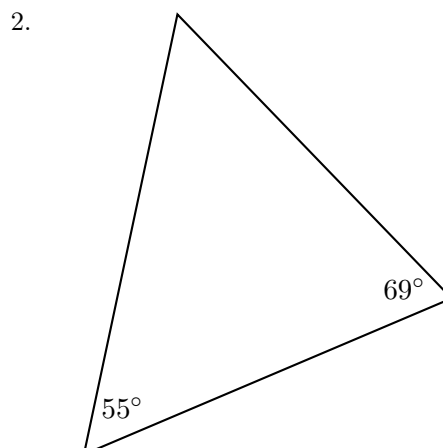
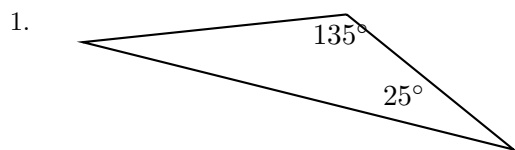

Calcul des Angles du Triangle (F) Réponses

Calculez l'angle manquant dans chaque triangle.

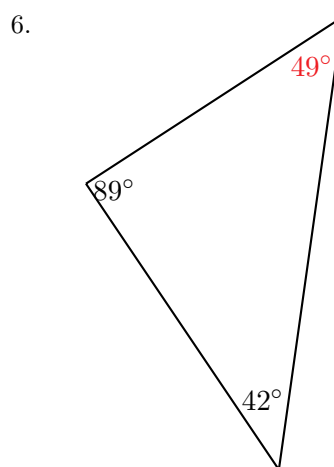
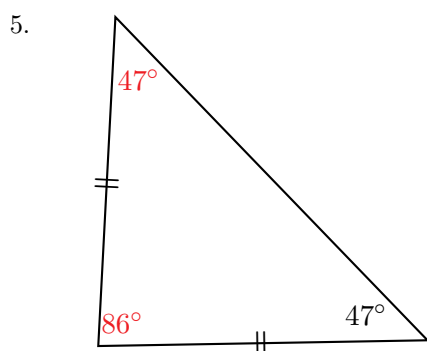
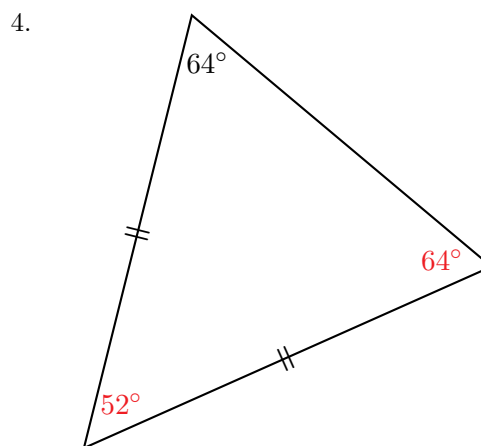
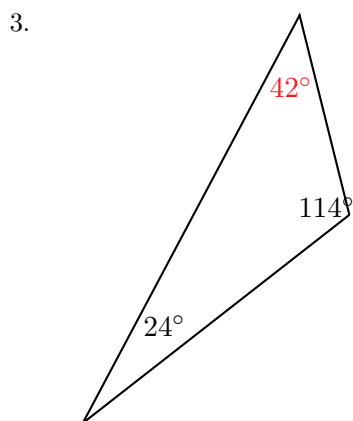
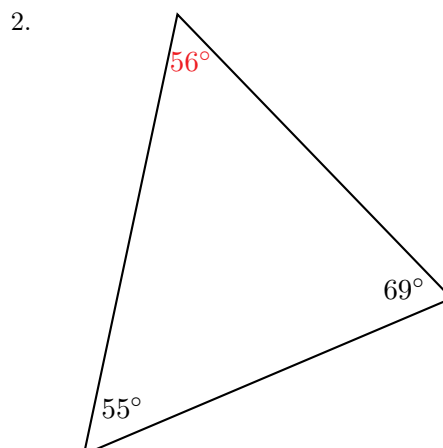
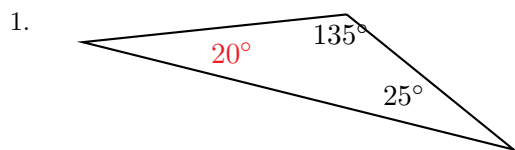

Calcul des Angles du Triangle (G)

Calculez l'angle manquant dans chaque triangle.

1.

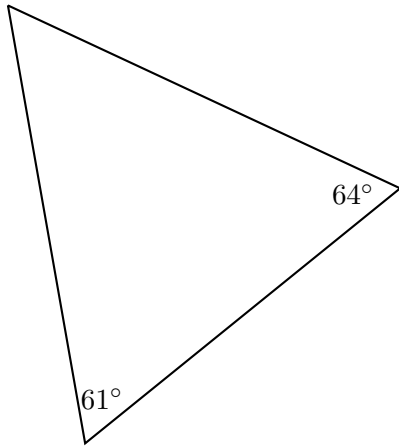

2.

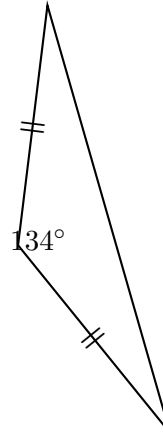

3.

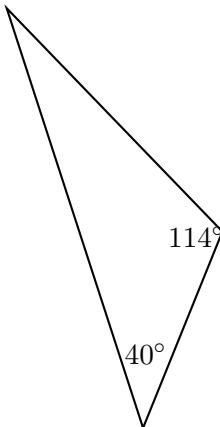

4.

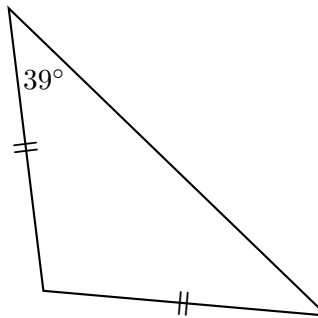

5.

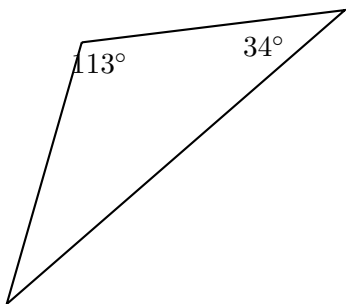

6.

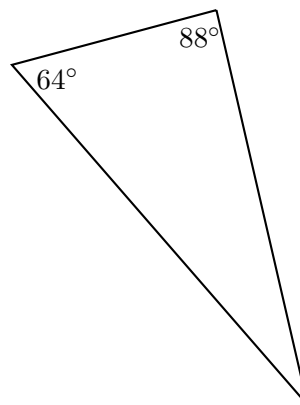

Calcul des Angles du Triangle (G) Réponses

Calculez l'angle manquant dans chaque triangle.

1.

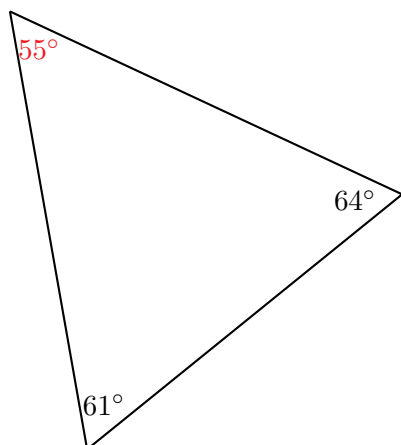

2.

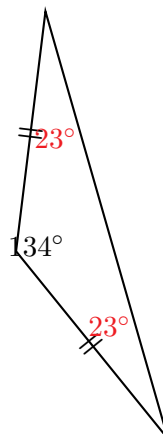

3.

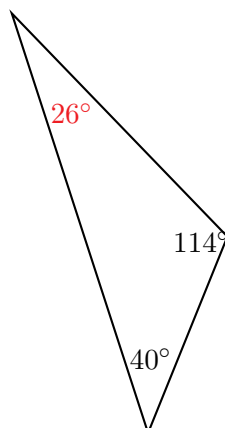

4.

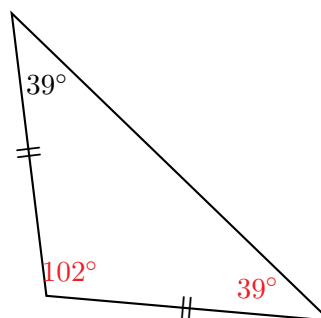

5.

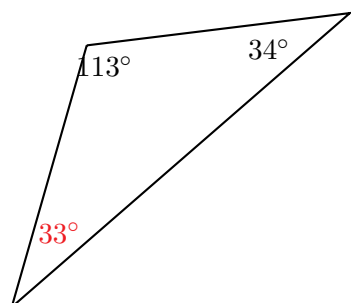

6.

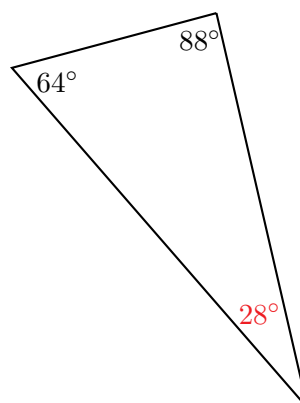

Calcul des Angles du Triangle (H)

Calculez l'angle manquant dans chaque triangle.

1.

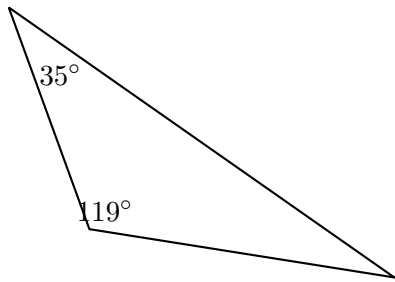

2.

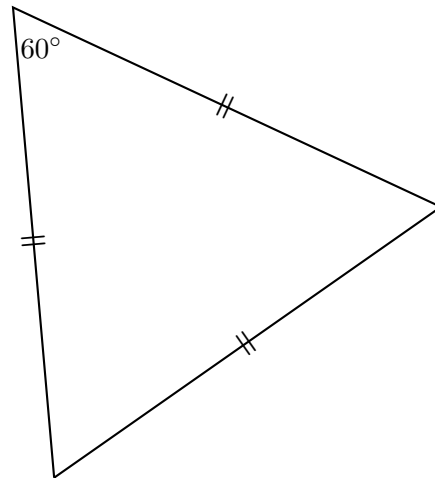

3.

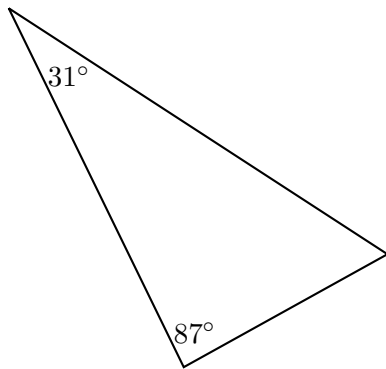

4.

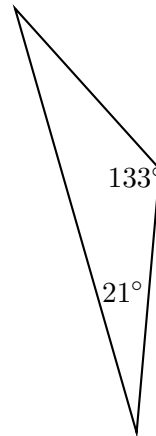

5.

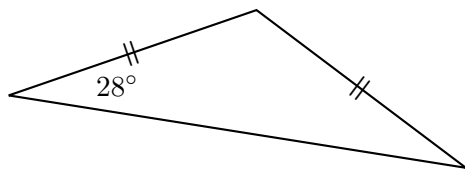

6.

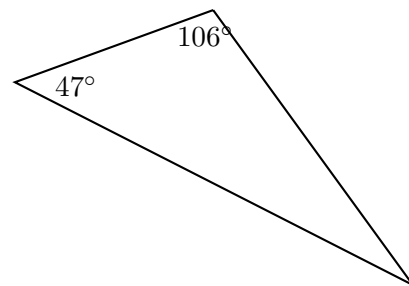

Calcul des Angles du Triangle (H) Réponses

Calculez l'angle manquant dans chaque triangle.

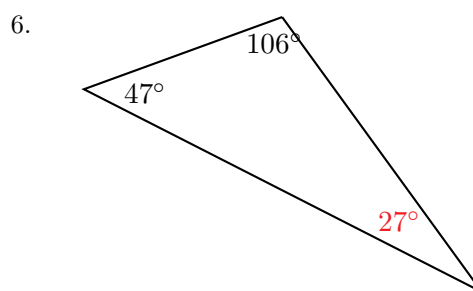
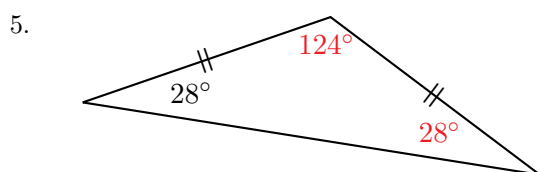
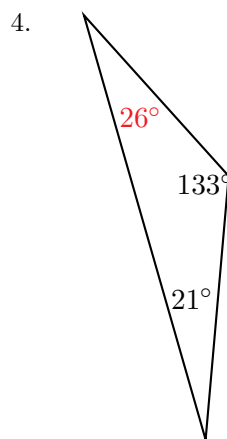
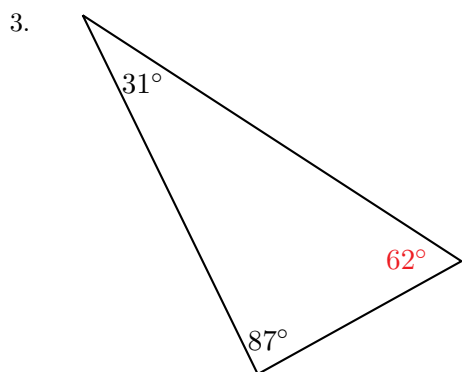
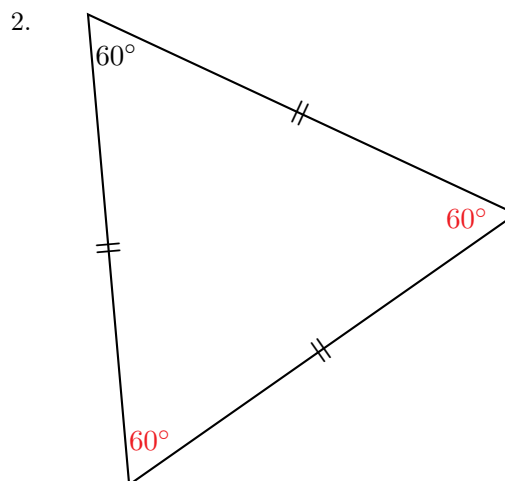
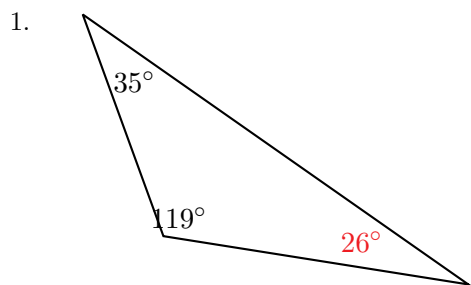

Calcul des Angles du Triangle (I)

Calculez l'angle manquant dans chaque triangle.

1.

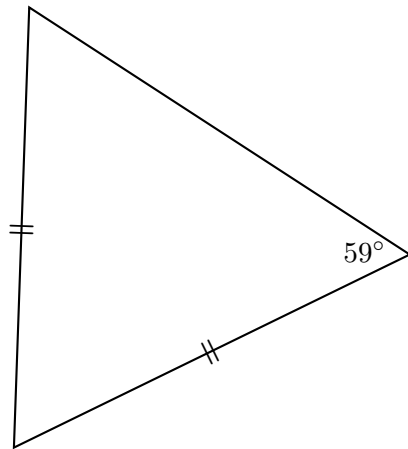

2.

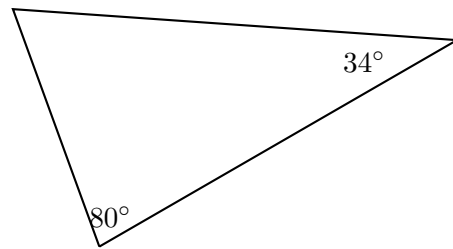

3.

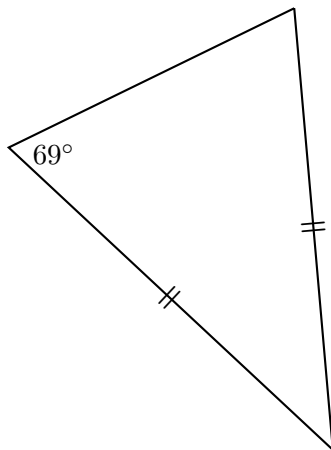

4.

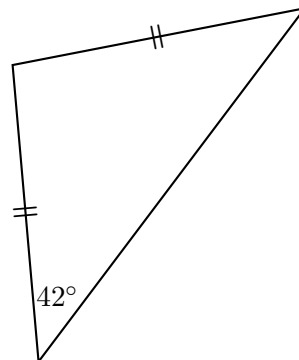

5.

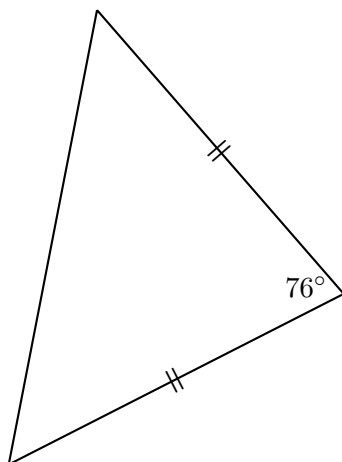

6.

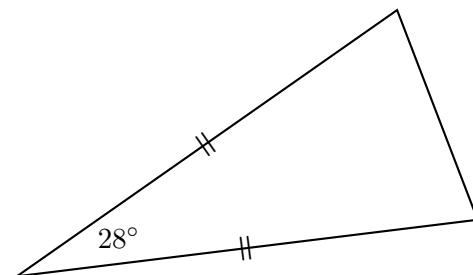

Calcul des Angles du Triangle (I) Réponses

Calculez l'angle manquant dans chaque triangle.

1.

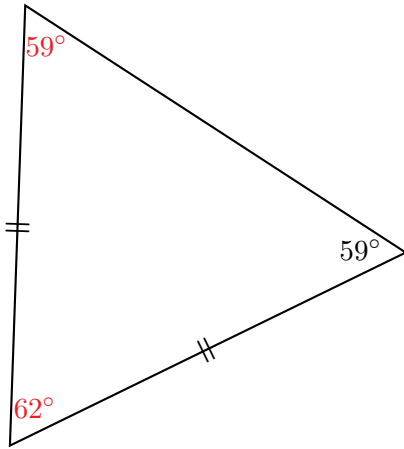

2.

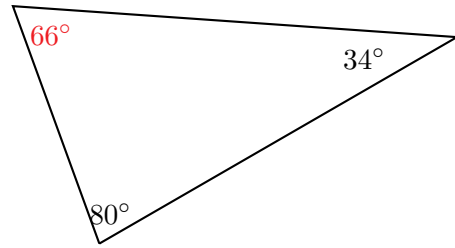

3.

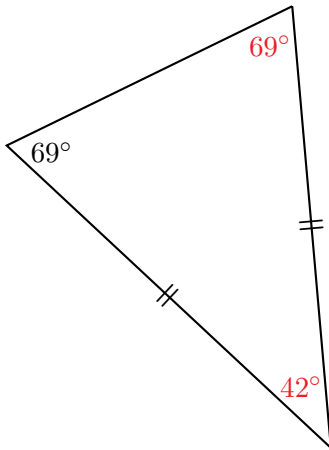

4.

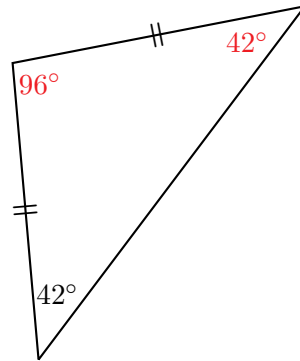

5.

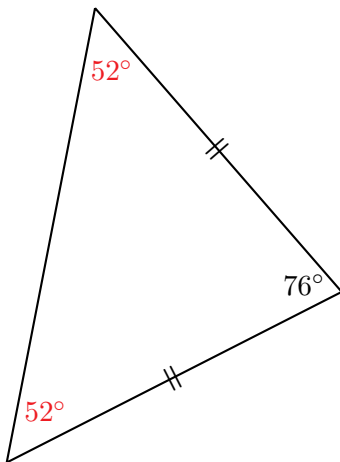

6.

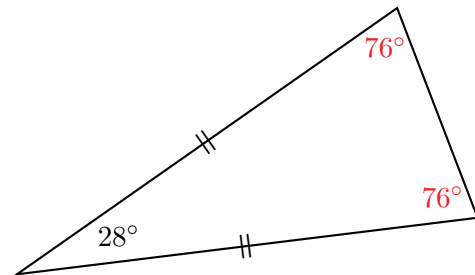

Calcul des Angles du Triangle (J)

Calculez l'angle manquant dans chaque triangle.

1.

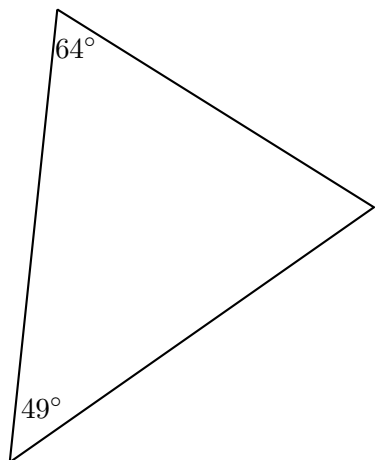

2.

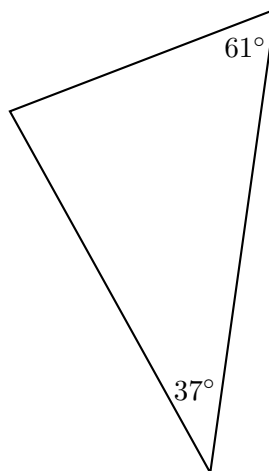

3.

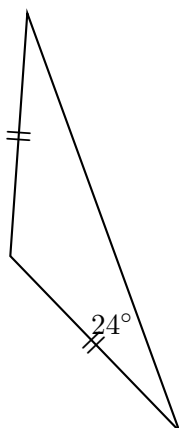

4.

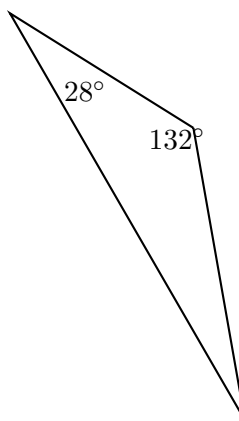

5.

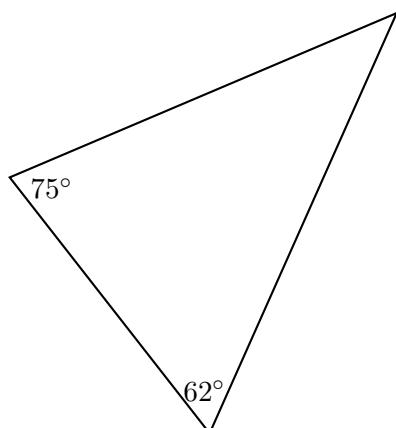

6.

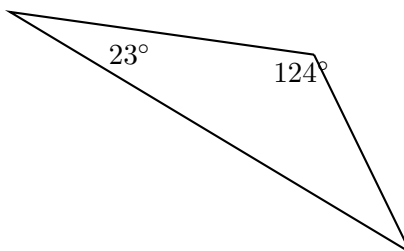

Calcul des Angles du Triangle (J) Réponses

Calculez l'angle manquant dans chaque triangle.

1.

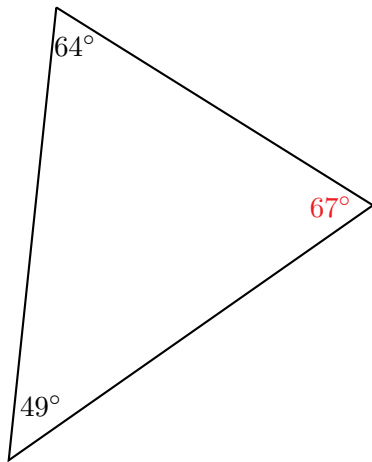

2.

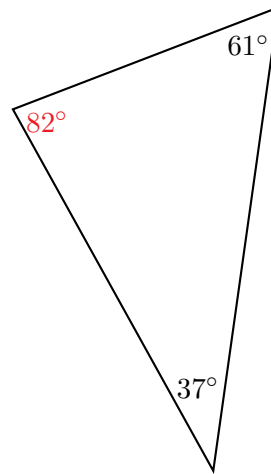

3.

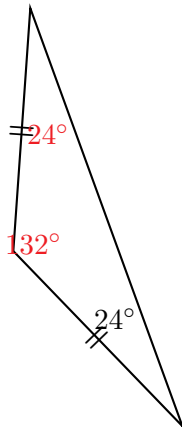

4.

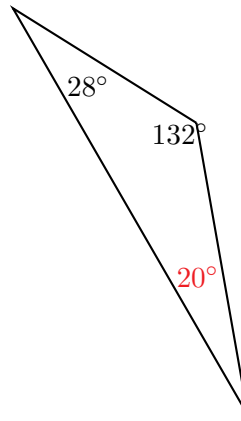

5.

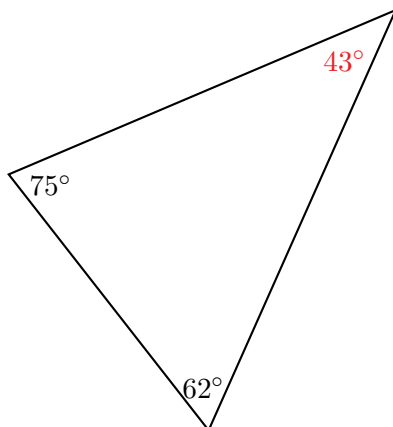

6.

