

Centres de Triangle (A)

Trouver chaque centre du triangle donné

1. - orthocentre

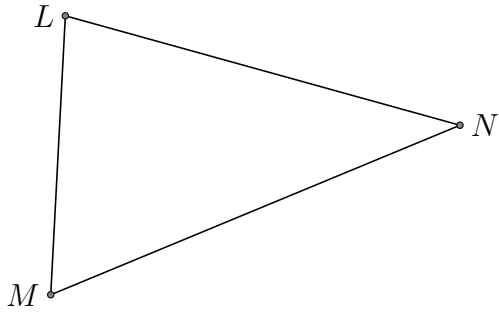

2. - orthocentre

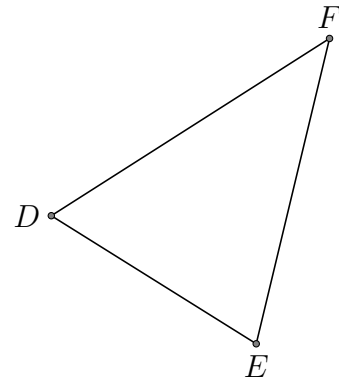

3. - orthocentre

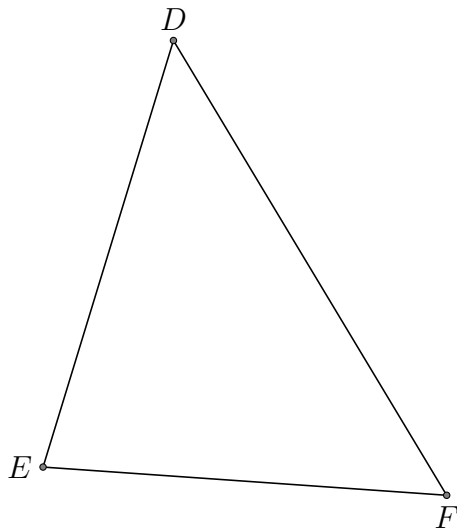

4. - orthocentre

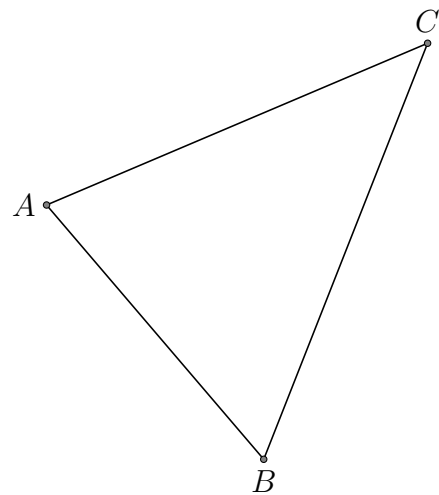

Centres de Triangle (A) Réponses

Trouver chaque centre du triangle donné

1. - orthocentre

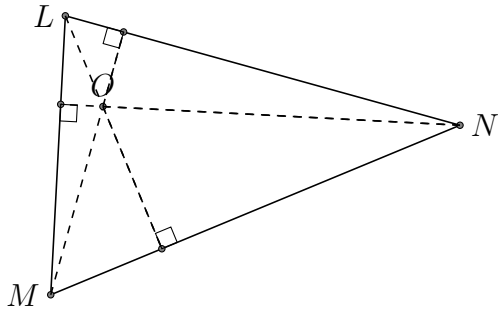

2. - orthocentre

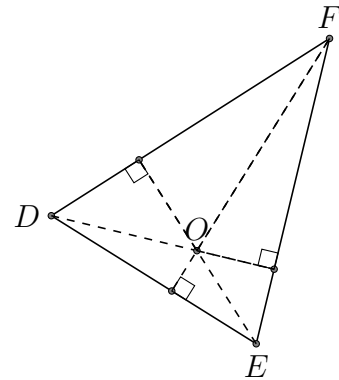

3. - orthocentre

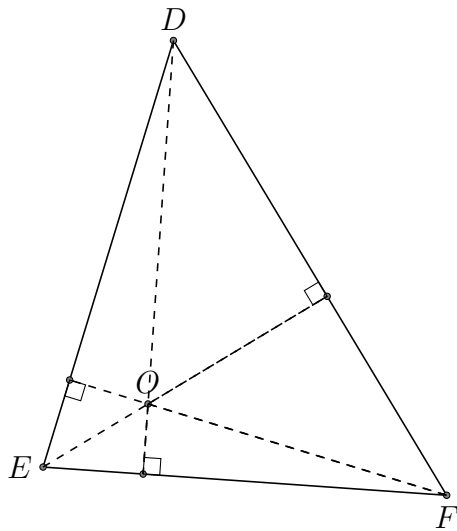

4. - orthocentre

